

LKS331, LKS332, LKS333

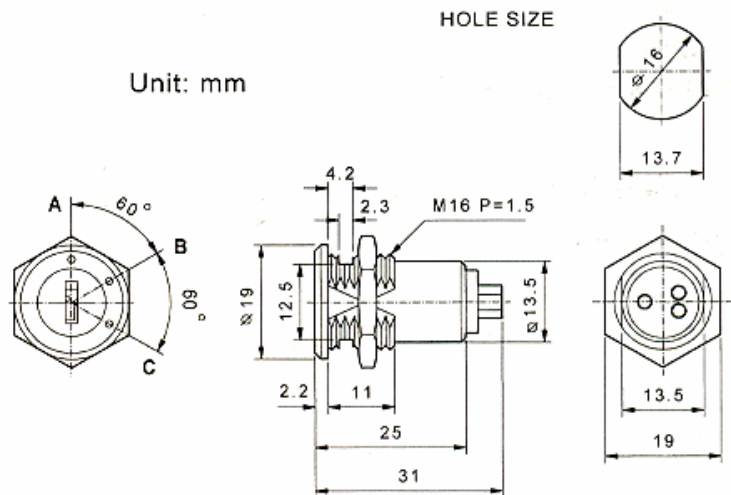

Descriptions:

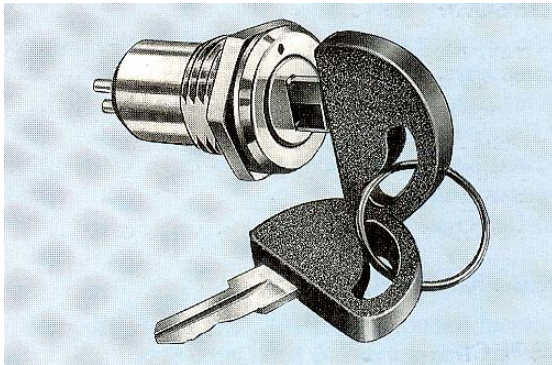





- Zinc alloy die cast housing, chrome plated.
- Brass key, nickel plated with plastic cap.
- Silver plated contacts and terminals
- LKS331 2 Positions (on-on) 60° index 3 Terminals.
- LKS332 2 Positions (off-on) 60° index 2 Terminals.
- LKS333 3 Positions (off-on-on) 60° index 3 Terminals.
- 16 combinations available.

Specifications:

- Contact Rating: 1A 125VAC, 0.5A 250VAC.
- Contact Resistance: 10 milli-Ohms Max.
- Insulation Resistance: 200 Meg-Ohms
- Dielectric Strength: 1000 VAC-1 Minute.

Key-Pull Figures:

- Off Position
- ┃–Indicates Key-Pull
- Indicates No Key-Pull

Fig. No.	Lock Number	Pole	Positions	Terminals	Key Pulls	Turn				Type
 1	LKS331	1	2	3	2	60°	On	On		SPDT
 2	LKS332	1	2	2	2	60°	Off	On		SPST
 3	LKS333	1	3	3	2	120°	Off	On	On	SPDT