

## TB-32 Series Pitch 11mm

### Specifications

- Barrier Material: Phenol, Black
- Terminals: Tin plated brass (Standard)
- Screws: Nickel plated steel
- Wire Range AWG: 12-18 STR
- Rating: 20 amperes, 300 VAC
- Insulation withstands voltage AC 2000V/MIN
- Insulation resistance 500MΩ or more at DC 500V

### How to Order (Ex. TB-321-8PH-S)

TB-32	<input type="checkbox"/> -	<input type="checkbox"/>	P	<input type="checkbox"/> -	<input type="checkbox"/>
	<b>Part Number</b>	<b>2-26: Pole Size</b>		<b>H: With Mounting Holes (If Necessary) (Necessary for 320, 320A, 323, 324)</b>	<b>S: Plate</b>

### Dimension: ±0.8m/m

POLE	TB-32- <input type="checkbox"/> P	TB-32- <input type="checkbox"/> PH
A	(P×11)+2	(P+2)×11+9.5
B	(P-1)×11	(P+1)×11+9.5

### TB-320

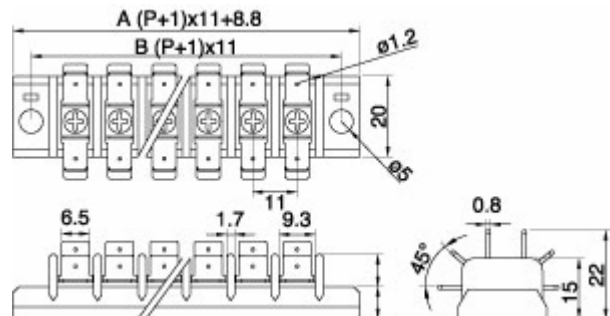

### TB-321

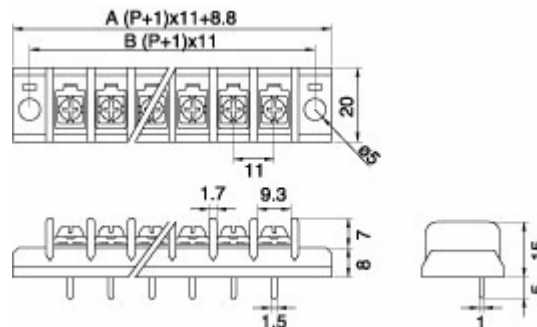

## TB-32 Series Pitch 11mm

**TB-322**

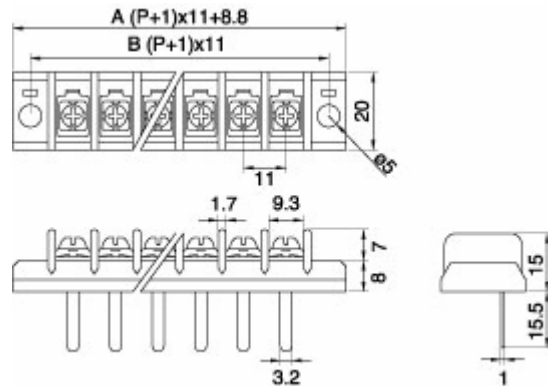
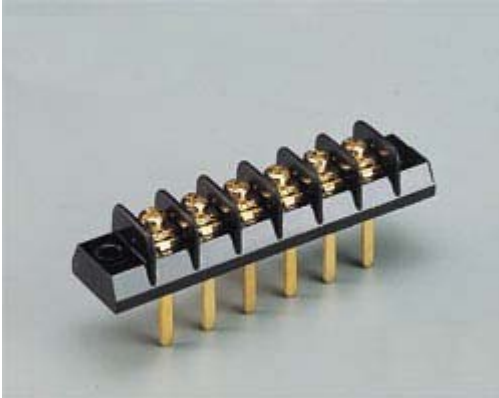

**TB-323**

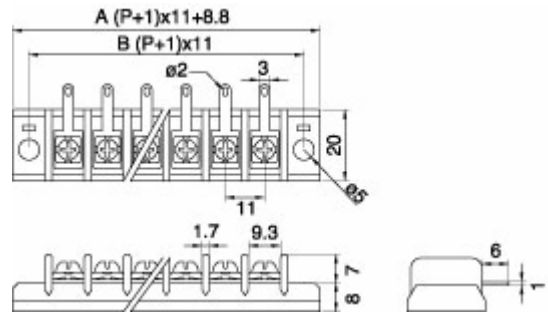

**TB-324**

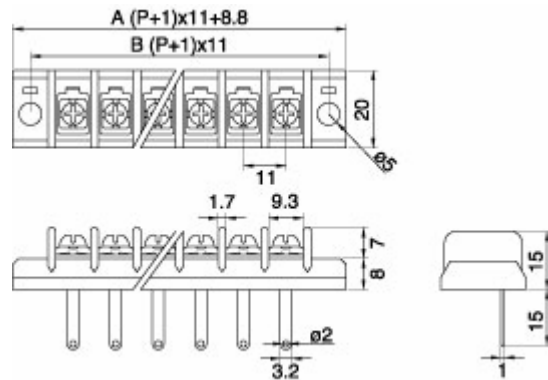
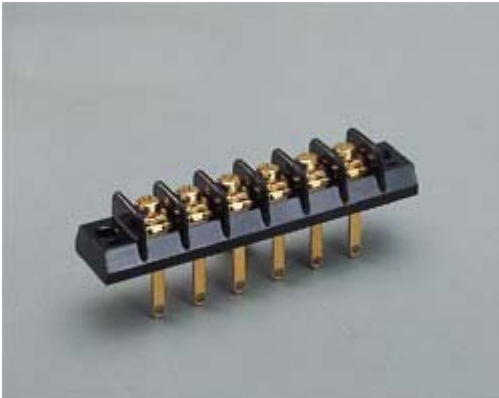

## TB-32 Series Pitch 11mm

**TB-325**

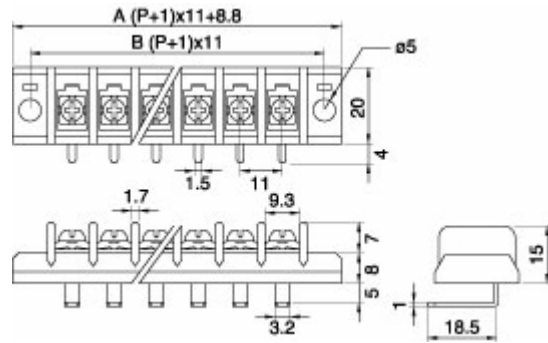

**TB-326**

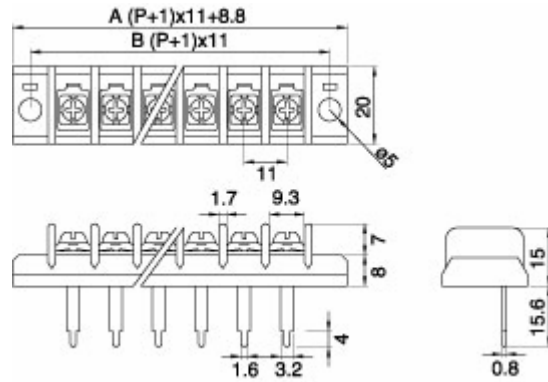

**TB-327**

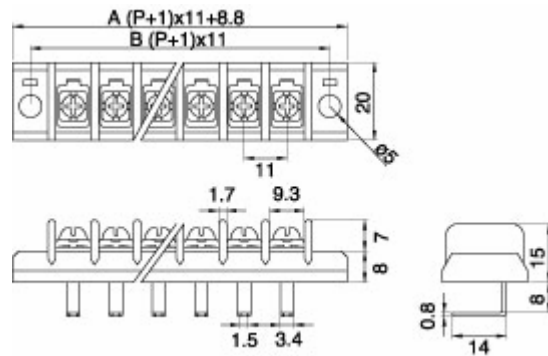

## TB-32 Series Pitch 11mm

**TB-328**

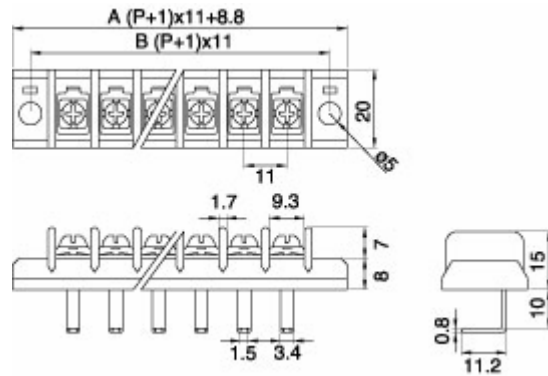

**TB-329**

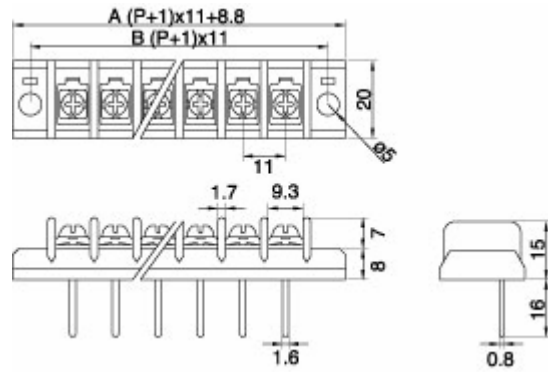
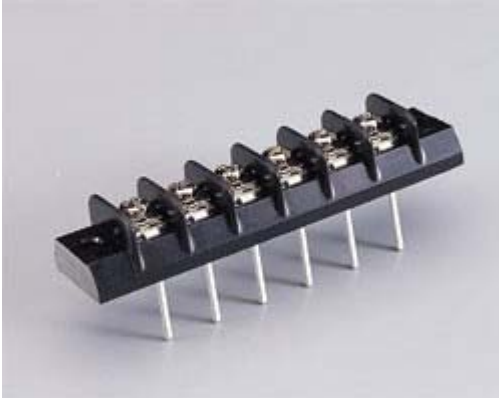

**TB-320A**

